

Super-rapid fittings for plastic tubes Series 6000

Tube external diameters: 3, 4, 5, 6, 8, 10, 12, 14, 16 mm
 Fittings threads: metric (M3, M5, M6, M7), BSP (G1/8, G1/4, G3/8, G1/2, G3/4), BSPT (R1/8, R1/4, R3/8, R1/2)



Series 6000 super-rapid fittings have been designed with a special collet which provides an homogeneous tight on the whole surface of plastic tubes, thus ensuring high reliability and a long service life, also after connections and disconnections of the tube are repeated several times. The wide range of these fittings includes many types of threads: metric, BSP and BSPT.

Sprint models are characterized by great reliability of female threads, both BSP and BSPT, with non-flat surfaces. This is possible thanks to a Teflon ring on the male thread, which guarantees a perfect seal between the two threads.

GENERAL DATA

Material	body and collet: nickel-plated brass; O-Ring: NBR; thread seal: PTFE - NBR - PA
Threads	series 6000 Micro: M3 - M5 - M7 - G1/8 - G1/4 series 6000: GAS conical ISO 7 (BSPT) GAS cylindrical ISO 228 (BSP) M5-M6 and other metric threads available on request NPT on request
Pressure	min -0,9 bar - max 16 bar (see tubing)
Tube to connect	Rilsan, PA 6-11-12, polyethylene, PU, Hytel Polyester
Diameters	series 6000 Micro: \varnothing 3 - 4 - 6 - 8 - 10 mm series 6000: \varnothing 4 - 5 - 6 - 8 - 10 - 12 - 14 - 16 mm
Fluid	compressed air (for other types of fluid, contact our engineers)
Temperature	series 6000 Micro: -10°C + 80°C (see data for tubing used) series 6000: -20°C + 80°C (see data for tubing used)

Fitting with connecting tube

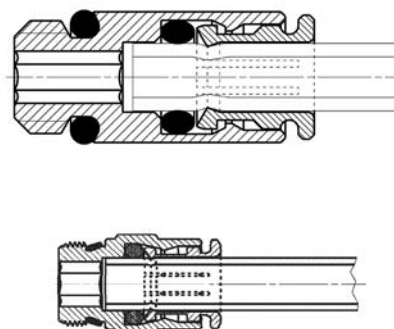

Fittings Mod. S6510

Male Connector Sprint®

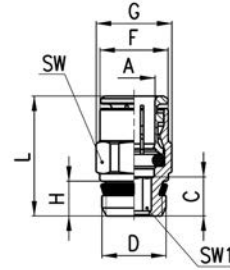

DIMENSIONS										
Mod.	A	D	C	F	G	H	L	SW	SW1	Weight (g)
S6510 4-1/8	4	G1/8	3,8	8,8	13,2	5,5	18	12	2,5	9
S6510 4-1/4	4	G1/4	5,5	8,8	15,2	7	19,5	14	2,5	15
S6510 5-1/8	5	G1/8	3,8	9,8	13,2	5,5	19	12	3	8
S6510 5-1/4	5	G1/4	5,5	9,8	15,2	7	20	14	3	14
S6510 6-1/8	6	G1/8	6	11,7	13,2	5,5	22	12	4	10
S6510 6-1/4	6	G1/4	5,5	11,7	15,2	7	21	14	4	14
S6510 6-3/8	6	G3/8	6,5	11,7	20,5	8	22,5	19	4	27
S6510 8-1/8	8	G1/8	7,5	13,7	15,2	5,5	25	14	5	13
S6510 8-1/4	8	G1/4	6,5	13,7	15,2	7	24	14	6	14
S6510 8-3/8	8	G3/8	6	13,7	20,5	8	23,5	19	6	25
S6510 8-1/2	8	G1/2	7,5	13,7	24,5	9	25	22	6	43
S6510 10-1/4	10	G1/4	8,3	15,4	18,5	7	28,5	17	7	23
S6510 10-3/8	10	G3/8	5,3	15,4	20,5	8	25,5	19	8	27
S6510 10-1/2	10	G1/2	4,8	15,4	24,5	9	25	22	8	39
S6510 12-1/4	12	G1/4	10,3	18,3	20,5	7	29,5	19	7	26
S6510 12-3/8	12	G3/8	9,3	18,3	20,5	8	28,5	19	9	30
S6510 12-1/2	12	G1/2	5,8	18,3	24,5	9	25	22	10	36
S6510 14-3/8	14	G3/8	10,3	20,5	24,5	8	30,5	22	9	42
S6510 14-1/2	14	G1/2	6,3	20,5	24,5	9	26,5	22	12	34
S6510 16-1/2	16	G1/2	9	23,5	26,5	9	32	24	-	42
S6510 16-3/4	16	G3/4	3,5	23,5	27,3	9	26,5	24	-	46

Fittings Mod. 6512 Micro

Metric-BSP Male Connector

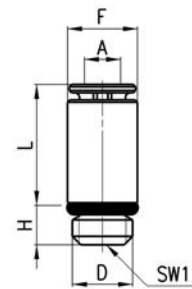

DIMENSIONS							
Mod.	A	D	F	H	L	SW1	Weight (g)
6512 3-M3	3	M3	5,8	2,5	10,2	1,5	1
6512 3-M5	3	M5	5,8	3,5	10	2	1
6512 4-M7-M	4	M7	9,4	5	17,5	2,5	5
6512 4-1/8-M	4	G1/8	11,2	5	13	2,5	9
6512 6-M7-M	6	M7	10,4	5	17	4	7
6512 6-1/8-M	6	G1/8	11,2	5	14	4	7
6512 8-1/8-M	8	G1/8	12,4	5	18,5	5	10
6512 10-1/4-M	10	G1/4	14,8	6	21	7	16

* = with gasket
 • = with O-Ring

Fittings Mod. 6512

Metric-BSP Male Connector

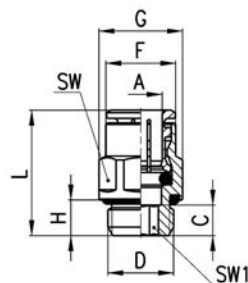

DIMENSIONS										
Mod.	A	D	C	F	G	H	L	SW	SW1	Weight (g)
6512 4-M5	4	M5	6	7,8	8,8	4	20	8	2	4
6512 4-M6	4	M6	6,5	8,8	9,9	4,5	20,5	9	2,5	6
6512 4-1/8	4	G1/8	5	8,8	13,5	6	19	12	2,5	10
6512 4-1/4	4	G1/4	6,5	8,8	16,4	7	20,5	15	2,5	14
6512 5-M5	5	M5	6	8,8	9,9	4	21	9	2	5
6512 6-M5	6	M5	6	11,7	13,2	4	22	12	2	8
6512 6-1/8	6	G1/8	5	11,7	13,5	6	21	12	4	10
6512 6-1/4	6	G1/4	6	11,7	16,4	7	22	15	4	13
6512 8-1/8	8	G1/8	8,5	13,7	15,2	6	26	14	5	15
6512 8-1/4	8	G1/4	7	13,7	16,4	7	24,5	15	6	17
6512 8-3/8	8	G3/8	6,5	13,7	20,5	7	23	19	6	27
6512 10-1/4	10	G1/4	9,8	15,4	18,5	7	30	17	7	26
6512 10-3/8	10	G3/8	5,3	15,4	20,5	7	24,5	19	8	27
6512 12-1/4	12	G1/4	10,5	18,3	20,5	7	29,5	19	7	29
6512 12-3/8	12	G3/8	5,8	18,3	20,5	7	24	19	9	24

Fittings Mod. 6463

Metric-BSP Female Connector

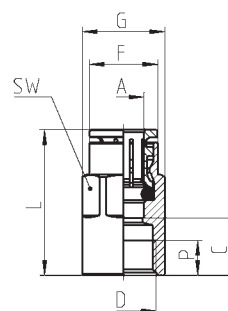

DIMENSIONS									
Mod.	A	D	C	F	G	L	SW	Weight (g)	
6463 4-M5	4	M5	6,5	7,8	8,8	20,5	9	8	
6463 4-1/8	4	G1/8	10	9	13	24	12	14	
6463 5-1/8	5	G1/8	10	9,8	13	25	12	14	
6463 6-1/8	6	G1/8	10	11,7	13	26	12	14	
6463 6-1/4	6	G1/4	11,5	11,9	16,5	27,5	15	23	
6463 8-1/8	8	G1/8	9,5	13,7	15,2	27	14	16	
6463 8-1/4	8	G1/4	11,5	13,7	16,5	29	15	23	
6463 10-1/4	10	G1/4	11,3	15,4	18,5	31,5	17	29	

Fittings Mod. S6520

Swivel Male Elbow Sprint®

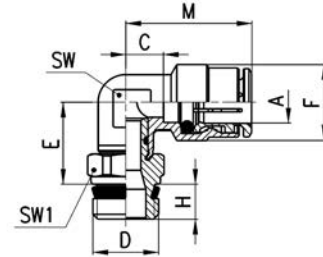

DIMENSIONS										
Mod.	A	D	C	E	F	H	M	SW	SW1	Weight (g)
S6520 4-1/8	4	G1/8	3,5	14,5	9	5,5	17,5	8	12	17
S6520 4-1/4	4	G1/4	3,5	14,5	9	7	17,5	8	14	23
S6520 5-1/8	5	G1/8	5,5	14,5	10	5,5	20,5	9	12	17
S6520 5-1/4	5	G1/4	5,5	14,5	10	7	20,5	9	14	23
S6520 6-1/8	6	G1/8	4	15	12,7	5,5	20	9	12	20
S6520 6-1/4	6	G1/4	4	15	12,7	7	20	9	14	23
S6520 6-3/8	6	G3/8	4	15,5	12,7	8	20	9	19	33
S6520 8-1/8	8	G1/8	5	16	14,2	5,5	22,5	11	12	22
S6520 8-1/4	8	G1/4	5	16	14,2	7	22,5	11	14	26
S6520 8-3/8	8	G3/8	5	16,5	14,2	8	22,5	11	19	41
S6520 8-1/2	8	G1/2	5	17	14,2	9	22,5	11	22	48
S6520 10-1/4	10	G1/4	5,8	18,5	16,5	7	26	13	14	32
S6520 10-3/8	10	G3/8	5,8	19	16,5	8	26	13	19	43
S6520 10-1/2	10	G1/2	5,8	19,5	16,5	9	26	13	22	62
S6520 12-1/4	12	G1/4	7,3	20	19,5	7	26,5	15	17	49
S6520 12-3/8	12	G3/8	7,3	20	19,5	8	26,5	15	19	48
S6520 12-1/2	12	G1/2	7,3	20,5	19,5	9	26,5	15	22	70
S6520 14-3/8	14	G3/8	8,3	21	21,5	8	28,5	17	19	74
S6520 14-1/2	14	G1/2	8,3	21,5	21,5	9	28,5	17	22	78

Fittings Mod. 6522 Micro

Metric Swivel Male Elbow

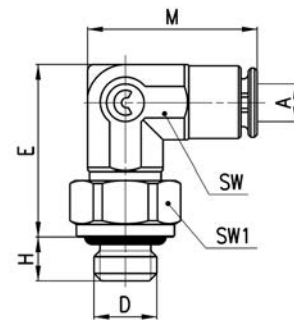

DIMENSIONS									
Mod.	A	D	E	H	M	SW	SW1	Weight (g)	
6522 3-M3	3	M3	13,7	2,5	13,7	6	6	4	*
6522 3-M5	3	M5	13,7	3,5	13,7	6	8	5	•

* = with gasket
• = with O-Ring

Fittings Mod. 6522

Metric-BSP Swivel Male Elbow

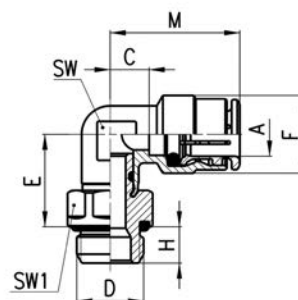

DIMENSIONS										
Mod.	A	D	C	E	F	H	M	SW	SW1	Weight (g)
6522 4-M5	4	M5	3,5	12,5	9	4	17,5	8	8	12
6522 4-1/8	4	G1/8	3,5	14,5	9	6	17,5	8	12	15
6522 4-1/4	4	G1/4	3,5	15,5	9	7	17,5	8	15	25
6522 5-M5	5	M5	5,5	12,5	10	4	20,5	9	8	13
6522 6-M5	6	M5	4	13	12,7	4	20	9	10	14
6522 6-1/8	6	G1/8	4	15	12,7	6	20	9	12	19
6522 6-1/4	6	G1/4	4	16	12,7	7	20	9	15	27
6522 8-1/8	8	G1/8	5	16	14,2	6	22,5	11	12	22
6522 8-1/4	8	G1/4	5	17	14,2	7	22,5	11	15	28
6522 8-3/8	8	G3/8	5	17	14,2	7	22,5	11	19	45
6522 10-1/4	10	G1/4	5,8	19,5	16,5	7	26	13	15	41
6522 10-3/8	10	G3/8	5,8	19,5	16,5	7	26	13	19	45
6522 12-1/4	12	G1/4	7,3	20	19,5	7	26,5	15	17	51
6522 12-3/8	12	G3/8	7,3	20,5	19,5	7	26,5	15	19	56

Fittings Mod. S6500

Metric Fix Male Elbow

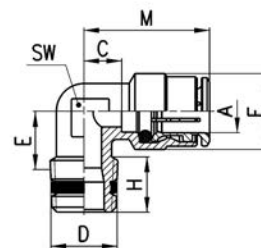

DIMENSIONS										
Mod.	A	D	C	E	F	H	M	SW	Weight (g)	
S6500 4-1/8	4	R1/8	3,5	8,5	9	7,5	17,5	8	9	
S6500 4-1/4	4	R1/4	5	11,5	9	12	19	9	13	
S6500 5-1/8	5	R1/8	5,5	8,5	10	7,5	20,5	9	13	
S6500 5-1/4	5	R1/4	5,5	11,5	10	12	20,5	9	17	
S6500 6-1/8	6	R1/8	4	9	12,7	7,5	20	9	15	
S6500 6-1/4	6	R1/4	4	11,5	12,7	12	20	9	16	
S6500 8-1/8	8	R1/8	5	10,5	14,2	6,5	22,5	11	18	
S6500 8-1/4	8	R1/4	5	11,5	14,2	12,5	22,5	11	21	
S6500 8-3/8	8	R3/8	7	13	14,2	11,5	24,5	12	25	
S6500 10-1/4	10	R1/4	5,8	13	16,5	11,5	26	13	33	
S6500 10-3/8	10	R3/8	5,8	13	16,5	12	26	13	33	
S6500 12-1/4	12	R1/4	7,3	14,5	19,5	11	26,5	15	46	
S6500 12-3/8	12	R3/8	7,3	13,5	19,5	11,5	26,5	15	39	

Fittings Mod. 6525
Long Swivel Male Elbow Sprint®

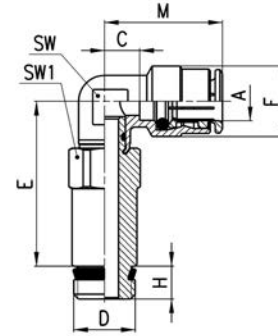

DIMENSIONS										
Mod.	A	D	C	E	F	H	M	SW	SW1	Weight (g)
6525 6-1/8	6	G1/8	4	33,8	12,7	5,5	20	9	12	34
6525 6-1/4	6	G1/4	4	34	12,7	7	20	9	14	47
6525 8-1/8	8	G1/8	5	34,8	14,2	5,5	22,5	11	12	35
6525 8-1/4	8	G1/4	5	35	14,2	7	22,5	11	14	50

Fittings Mod. 6621 Micro
Complete Metric Adjustable
Single Banjo

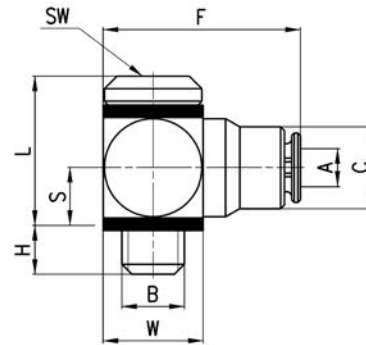

DIMENSIONS										
Mod.	A	B	C	F	H	L	S	W	SW	Weight (g)
6621 3-M3	3	M3	5,8	14,2	2,5	9,3	3,5	6	1,5	5
6621 3-M5	3	M5	6,5	16	3,2	11,9	4,8	8	2	6

Fitting Mod. 6501 4-M5
Metric Fix Male Elbow

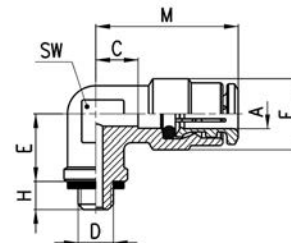

DIMENSIONS										
Mod.	A	D	C	E	F	H	M	SW	Weight (g)	
6501 4-M5	4	M5	3,5	6	9	4	17,5	8	11	

Fittings Mod. S6430

Swivel Male Tee Sprint®

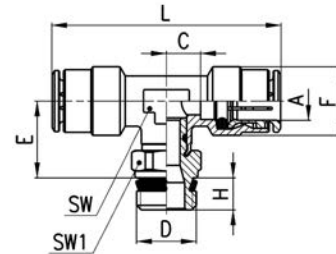
DIMENSIONS

Mod.	A	D	C	E	F	H	L	SW	SW1	Weight (g)
S6430 4-1/8	4	G1/8	3,5	14,5	9	5,5	35	8	12	18
S6430 5-1/8	5	G1/8	5,5	14,5	10	5,5	41	9	12	24
S6430 5-1/4	5	G1/4	5,5	14,5	10	7	41	9	14	30
S6430 6-1/8	6	G1/8	4	15	12,7	5,5	40	9	12	28
S6430 6-1/4	6	G1/4	4	15	12,7	7	40	9	14	33
S6430 8-1/8	8	G1/8	5	16	14,2	5,5	45	11	12	37
S6430 8-1/4	8	G1/4	5	16	14,2	7	45	11	14	42
S6430 8-3/8	8	G3/8	5	16,5	14,2	8	45	11	19	51
S6430 10-1/4	10	G1/4	5,8	18,5	16,5	7	52	13	14	56
S6430 10-3/8	10	G3/8	5,8	19	16,5	8	52	13	19	67
S6430 10-1/2	10	G1/2	5,8	19,5	16,5	9	52	13	22	85
S6430 12-1/4	12	G1/4	7,3	20	19,5	7	53	15	17	60
S6430 12-3/8	12	G3/8	7,3	20	19,5	8	53	15	19	65
S6430 12-1/2	12	G1/2	7,3	20,5	19,5	9	53	15	22	89
S6430 14-1/2	14	G1/2	8,3	21,5	21,5	9	57	17	22	88

Fittings Mod. 6432 Micro

Metric Swivel Male Tee

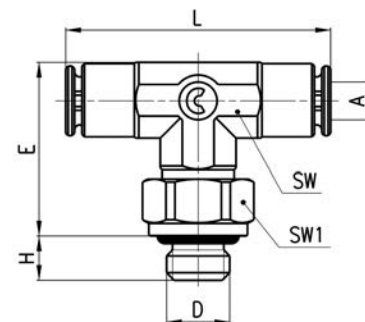

DIMENSIONS

Mod.	A	D	E	H	L	SW	SW1	Weight (g)
6432 3-M3	3	M3	13,7	2,5	21,4	6	6	5 *
6432 3-M5	3	M5	13,7	3,5	21,4	6	8	6 •

 * = with gasket
 • = with O-Ring

Fittings Mod. 6432

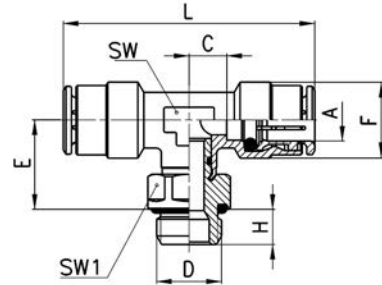
Metric-BSP Swivel Male Tee



DIMENSIONS										
Mod.	A	D	C	E	F	H	L	SW	SW1	Weight (g)
6432 4-M5	4	M5	3,5	12,5	9	4	35	8	8	14
6432 4-1/8	4	G1/8	3,5	14,5	9	6	35	8	12	19
6432 5-M5	5	M5	5,5	12,5	10	4	41	9	8	19
6432 6-1/8	6	G1/8	4	15	12,7	6	40	9	12	29
6432 6-1/4	6	G1/4	4	16	12,7	7	40	9	15	30
6432 8-1/8	8	G1/8	5	16	14,2	6	45	11	12	37
6432 8-1/4	8	G1/4	5	17	14,2	7	45	11	15	39
6432 8-3/8	8	G3/8	5	17	14,2	7	45	11	19	55
6432 10-1/4	10	G1/4	5,8	19,5	16,5	7	52	13	15	59
6432 10-3/8	10	G3/8	5,8	19,5	16,5	7	52	13	19	56
6432 12-1/4	12	G1/4	7,3	20	19,5	7	53	15	17	60
6432 12-3/8	12	G3/8	7,3	20,5	19,5	7	53	15	19	80

Fittings Mod. S6440

Lateral Swivel Male Tee Sprint®

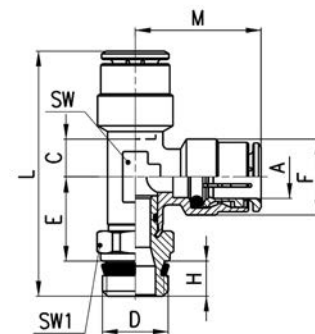

DIMENSIONS											
Mod.	A	D	C	E	F	H	L	M	SW	SW1	Weight (g)
S6440 4-1/8	4	G1/8	3,5	14,5	9	5,5	37,5	17,5	8	12	23
S6440 5-1/8	5	G1/8	5,5	14,5	10	5,5	40,5	20,5	9	12	24
S6440 6-1/8	6	G1/8	4	15	12,7	5,5	40,5	20	9	12	26
S6440 6-1/4	6	G1/4	4	15	12,7	7	42	20	9	14	31
S6440 8-1/8	8	G1/8	5	16	14,2	5,5	44	22,5	11	12	37
S6440 8-1/4	8	G1/4	5	16	14,2	7	45,5	22,5	11	14	35
S6440 8-3/8	8	G3/8	5	16,5	14,2	8	47	22,5	11	19	52
S6440 10-1/4	10	G1/4	5,8	18,5	16,5	7	51,5	26	13	14	43
S6440 10-3/8	10	G3/8	5,8	18,5	16,5	8	53	26	13	19	66
S6440 12-3/8	12	G3/8	7,3	19,5	19,5	8	54,5	26,5	15	19	65
S6440 14-1/2	14	G1/2	8,3	21,5	21,5	9	59	28,5	17	22	88

Fittings Mod. 6442 Micro

Lateral Metric Swivel Male Tee

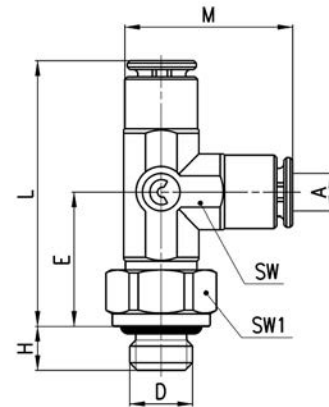

DIMENSIONS

Mod.	A	D	E	H	L	M	SW	SW1	Weight (g)
6442 3-M3	3	M3	10,7	2,5	21,4	13,7	6	6	5 *
6442 3-M5	3	M5	12,2	3,5	21,4	13,7	6	8	6 •

 * = with gasket
 • = with O-Ring

Fittings Mod. 6442

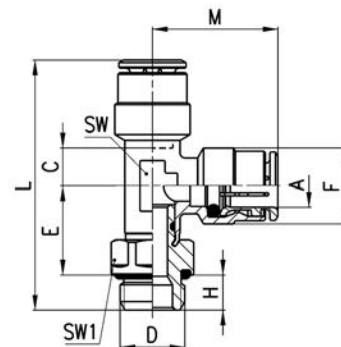
Lateral Metric-BSP Swivel Male Tee

DIMENSIONS

Mod.	A	D	C	E	F	H	L	M	SW	SW1	Weight (g)
6442 4-M5	4	M5	3,5	12,5	9	4	34	17,5	8	8	18
6442 4-1/8	4	G1/8	3,5	14,5	9	6	38	17,5	8	12	19
6442 5-M5	5	M5	5,5	12,5	10	4	36,5	20,5	9	8	19
6442 6-1/8	6	G1/8	4	15	12,7	6	41	20	9	12	26
6442 6-1/4	6	G1/4	4	16	12,7	7	43	20	9	15	36
6442 8-1/8	8	G1/8	5	16	14,2	6	44,5	22,5	11	12	31
6442 8-1/4	8	G1/4	5	17	14,2	7	46,5	22,5	11	15	42
6442 8-3/8	8	G3/8	5	17	14,2	7	46,5	22,5	11	19	50
6442 10-1/4	10	G1/4	5,8	19,5	16,5	7	52,5	26	13	15	46
6442 10-3/8	10	G3/8	5,8	19,5	16,5	7	52,5	26	13	19	66
6442 12-1/4	12	G1/4	7,3	20	16,5	7	53,5	26,5	15	17	73
6442 12-3/8	12	G3/8	7,3	20,5	19,5	7	54	26,5	15	19	64

Fittings Mod. 6452 Micro

Metric Swivel Male Y

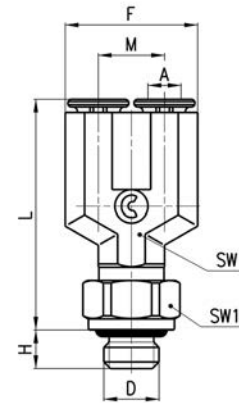

DIMENSIONS

Mod.	A	D	F	H	L	M	SW	SW1	Weight (g)
6452 3-M3	3	M3	12	2,5	20,9	6	6	6	6
6452 3-M5	3	M5	12	3,5	20,9	6	6	8	7

* = with gasket
● = with O-Ring

Fittings Mod. 6451 - S6450

Mod. 6451: Metric Adjustable Male Y

Mod. S6450: Swivel Male Y Sprint®

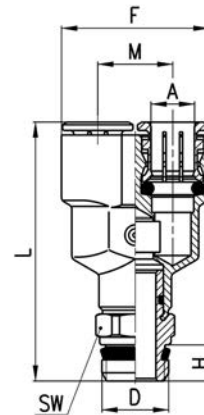

DIMENSIONS

Mod.	A	D	F	H	L	M	SW	Weight (g)
6451 4-M5	4	M5	18	4	26,5	9	-	17
6451 6-M5	6	M5	24,5	4	29,5	12,5	-	27
S6450 4-1/8	4	G1/8	18	5,5	38	9	12	23
S6450 6-1/8	6	G1/8	24,5	5,5	41,5	12,5	12	33
S6450 8-1/8	8	G1/8	28,5	5,5	48,5	14,5	14	48
S6450 8-1/4	8	G1/4	28,5	7	50	14,5	14	50

* = not swivel Model with gasket

Fittings Mod. 6622

Complete BSP Swivel Single Banjo

* Complete Metric Swivel Single Banjo

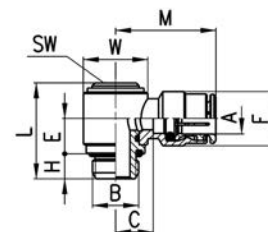

DIMENSIONS

Mod.	A	B	C	E	F	H	L	M	SW	W	Weight (g)	Notes
6622 4-M5	4	M5	4	5,7	8,8	4	15,8	18	2,5	Ø 8	10	*
6622 4-1/8	4	G1/8	7,5	10,2	9	5	25	21,5	4	Ø 14	22	
6622 6-1/8	6	G1/8	8	10,2	12,7	5	25	24	4	Ø 14	24	
6622 6-1/4	6	G1/4	10	9,1	12,7	6	25,3	26	5	Ø 18	35	
6622 8-1/8	8	G1/8	8	10,2	14,2	5	25	25,5	4	Ø 14	28	
6622 8-1/4	8	G1/4	10	9,1	14,2	6	25,3	27,5	5	Ø 18	39	
6622 10-1/4	10	G1/4	8,8	9,1	16,5	6	25,3	29	5	Ø 18	42	

Fittings Mod. 6632

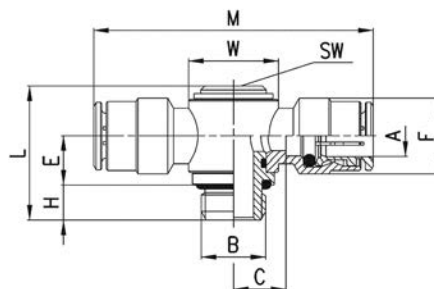
 Complete BSP Swivel
 Double Banjo

DIMENSIONS

Mod.	A	B	C	E	F	H	L	M	W	SW	Weight (g)
6632 4-1/8	4	G1/8	7,5	10,2	9	5	25	43	∅ 14	4	24
6632 6-1/8	6	G1/8	8	10,2	12,7	5	25	48	∅ 14	4	33
6632 6-1/4	6	G1/4	10	9,1	12,7	6	25,3	52	∅ 18	5	35
6632 8-1/8	8	G1/8	8	10,2	14,2	5	25	51	∅ 14	4	39
6632 8-1/4	8	G1/4	10	9,1	14,2	6	25,3	55	∅ 18	5	40
6632 10-1/4	10	G1/4	8,8	9,1	16,5	6	25,3	58	∅ 18	5	50

Fittings Mod. 6620 assembled with Mod. 1631, 1635

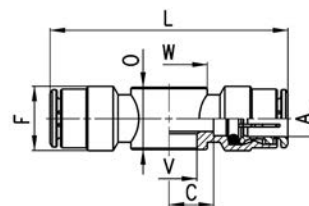
Double Banjo

DIMENSIONS

Mod.	A	C	F	L	O	V	W	Weight (g)
6620 4-M5	4	5	9	38	9	5,1	∅ 9	13
6620 4-1/8	4	7,5	9	43	14,5	9,8	∅ 14	19
6620 6-1/8	6	8	12,7	48	14,5	9,8	∅ 14	24
6620 6-1/4	6	10	12,7	52	14,5	13,2	∅ 18	26
6620 8-1/8	8	8	14,2	51	14,5	9,8	∅ 14	32
6620 8-1/4	8	10	14,2	55	14,5	13,2	∅ 18	34

Fittings Mod. 1631 with gaskets

 01... = Single Banjo Stem
 02... = Double Banjo Stem
 03... = Triple Banjo Stem



Mod.

1631 01-
1631 02-
1631 03-

 Drawings and dimensions on
 page 4/2.05.09

Fittings Mod. 6610 assembled with Mod. 1631, 1635

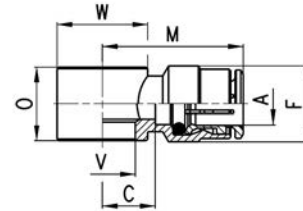
Single Banjo



DIMENSIONS								
Mod.	A	C	F	M	O	V	W	Weight (g)
6610 4-M5	4	5	9	19	9	5,1	Ø 9	9
6610 4-M6	4	5	9	19	9	5,1	Ø 9	8 •
6610 4-1/8	4	7,5	9	21,5	14,5	9,8	Ø 14	14
6610 5-M5	5	5	10	20	9	5,1	Ø 9	9
6610 5-M6	5	5	10	20	9	5,1	Ø 9	8 •
6610 5-1/8	5	8	10	23	14,5	9,8	Ø 14	16
6610 6-M5	6	6,5	12,7	22,5	9	5,1	Ø 10	12
6610 6-M6	6	6,5	12,7	22,5	9	5,1	Ø 10	12 •
6610 6-1/8	6	8	12,7	24	14,5	9,8	Ø 14	16
6610 6-1/4	6	10	12,7	26	14,5	13,2	Ø 18	19
6610 8-1/8	8	8	14,2	25,5	14,5	9,8	Ø 14	19
6610 8-1/4	8	10	14,2	27,5	14,5	13,2	Ø 18	22
6610 8-3/8	8	11	14,2	28,5	14,5	16,7	Ø 21	23
6610 10-1/4	10	8,8	16,5	29	14,5	13,2	Ø 18	22 *
6610 10-3/8	10	10,3	16,5	30,5	14,5	16,7	Ø 21	23 *
6610 12-1/2	12	12,8	16,5	32	14,5	21	Ø 26	37 *

• = assembly required with Mod. SCU, SVU, SCO... M5 only
 * = assembly required with Mod. 1635 only

Fittings Mod. 6811

Metric Male Adaptor Sprint®

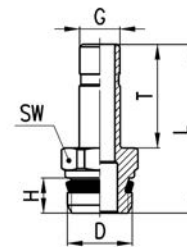

DIMENSIONS							
Mod.	G	D	H	T	L	SW	Weight (g)
6811 4-M5	4	M5	4	16,5	24,5	8	3 *
6811 4-1/8	4	G1/8	5,5	16,5	27,8	12	10
6811 5-1/8	5	G1/8	5,5	18	29,3	12	9
6811 5-1/4	5	G1/4	7	18	31	14	11
6811 6-1/8	6	G1/8	5,5	18	29,3	12	10
6811 6-1/4	6	G1/4	7	18	31	14	12
6811 8-1/8	8	G1/8	5,5	20,5	31,8	12	12
6811 8-1/4	8	G1/4	7	20,5	33,5	14	13
6811 10-1/4	10	G1/4	7	23	36	14	16
6811 10-3/8	10	G3/8	8	23	37,3	19	25
6811 12-3/8	12	G3/8	8	24	38,3	19	25
6811 14-1/2	14	G1/2	9	28	44	22	39

* = with O-Ring

Fittings Mod. S6110

45° Male Elbow Sprint®

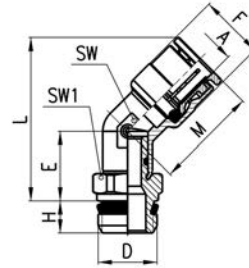

DIMENSIONS										
Mod.	A	D	E	F	H	L	M	SW	SW1	Weight (g)
S6110 6-1/8	6	G1/8	14	12,7	5,5	32,5	20,5	11	12	21
S6110 6-1/4	6	G1/4	14	12,7	7	34,5	20,5	11	14	25
S6110 8-1/8	8	G1/8	14	14,2	5,5	32,5	22,5	11	12	21
S6110 8-1/4	8	G1/4	14	14,2	7	34,5	22,5	11	14	26
S6110 8-3/8	8	G3/8	14,5	14,2	8	35	22,5	11	19	38
S6110 10-1/4	10	G1/4	15,5	16,5	7	39,5	26,5	15	17	39
S6110 10-3/8	10	G3/8	15,5	16,5	8	39,5	26,5	15	19	44
S6110 10-1/2	10	G1/2	16	16,5	9	40	26,5	15	22	57
S6110 12-1/4	12	G1/4	15,5	19,5	7	40,5	26,5	15	17	41
S6110 12-3/8	12	G3/8	15,5	19,5	8	40,5	26,5	15	19	46
S6110 12-1/2	12	G1/2	16	19,5	9	41	26,5	15	22	59

Fittings Mod. 6590 Micro

Bulkhead Connector

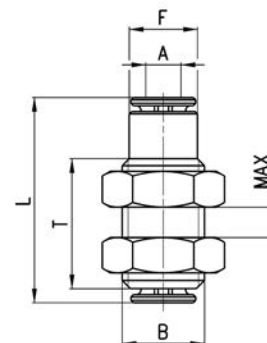

DIMENSIONS							
Mod.	A	B	F	L	MAX	T	Weight (g)
6590 3	3	M7x0,75	5,8	18,4	5	11,4	4

Fittings Mod. 6590

Bulkhead Connector

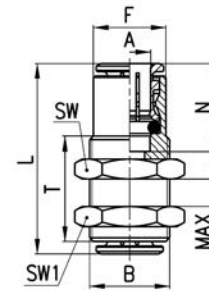

DIMENSIONS										
Mod.	A	B	F	L	N	MAX	SW	SW1	T	Weight (g)
6590 4	4	M10x1	8,8	29	14	10,5	14	14	20	16
6590 5	5	M12x1	9,8	31	15	10,5	17	17	20	25
6590 6	6	M14x1	12,5	33	16	10,5	17	17	20	28
6590 8	8	M16x1	14,5	36	17,5	11,5	19	19	21	35
6590 10	10	M18x1	16,3	41,5	20,2	13	22	22	23,5	51
6590 12	12	M20x1	18,8	39,5	19,2	14,5	24	24	25	56
6590 14	14	M22x1	20,5	41,5	20,2	17,5	27	27	30	82

Fittings Mod. 6580 Micro

Union Connector

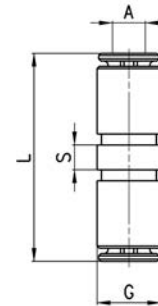

DIMENSIONS					
Mod.	A	G	L	S	Weight (g)
6580 3	3	5,8	19,9	2,2	2

Fittings Mod. 6580

Union Connector

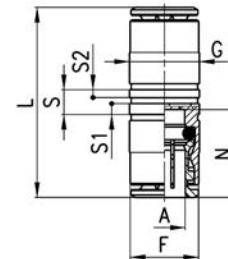

DIMENSIONS									
Mod.	A	F	G	L	N	S	S1	S2	Weight (g)
6580 4	4	8,4	9	29	14	5	2,2	1,6	11
6580 5	5	9,4	10	31	15	5	2,2	1,6	15
6580 6	6	11,7	12	34	16	5	2,2	1,6	16
6580 8	8	13,7	14	37	17,5	5	2,2	1,6	23
6580 10	10	15,4	17	41,5	20,2	5	2,2	1,6	33
6580 12	12	18,3	19	39,5	19,2	5,2	2,2	1,6	40
6580 14	14	20,5	21	41,5	20,2	5,2	2,2	1,6	47

Fittings Mod. 6580
Reducer Union Connector

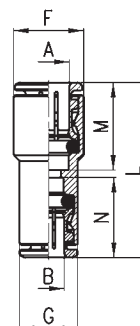

DIMENSIONS

Mod.	A	B	F	G	L	M	N	Weight (g)
6580 6-4	6	4	12	9	31,5	16	14	12
6580 8-6	8	6	14	12,2	35	17,5	16	19
6580 10-8	10	8	16	14	39	20	17,5	25
6580 12-10	12	10	19	16	40,5	19	20	35

Fittings Mod. 6593
BSP Female Bulkhead

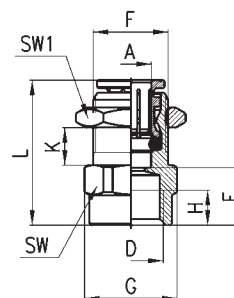

DIMENSIONS

Mod.	A	D	E	F	G	H	L	K (max)	K (min)	SW	SW1	Weight (g)
6593 6-1/8	6	G1/8	10	M12x1	16,4	6	24,5	8,5	2	15	17	19
6593 6-1/4	6	G1/4	11,5	M12x1	18,5	7	26	6,5	2	17	17	22
6593 8-1/8	8	G1/8	10	M15x1	18,5	6	27	9,5	2	17	19	26
6593 8-1/4	8	G1/4	11,5	M15x1	18,5	7	28,5	9,5	2	17	19	26
6593 10-3/8	10	G3/8	12,8	M18x1	24,5	8	32,5	12	2	22	22	43

Fittings Mod. 6550 Micro
Elbow connector

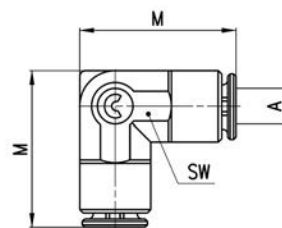

DIMENSIONS

Mod.	A	M	SW	Weight (g)
6550 3	3	13,7	6	3

Fittings Mod. 6550

Elbow connector

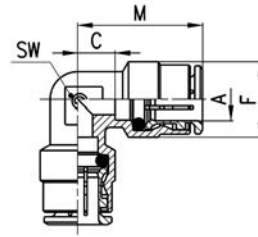

DIMENSIONS

Mod.	A	C	F	M	SW	Weight (g)
6550 4	4	3,5	9	17,5	8	8
6550 5	5	5,5	10	20,5	9	15
6550 6	6	4	12,7	20	9	17
6550 8	8	5	14,2	22,5	11	22
6550 10	10	5,8	16,5	26	13	30
6550 12	12	7,3	19,5	26,5	15	44
6550 14	14	8,3	21,5	28,5	17	71

Fittings Mod. 6540 Micro

Tee Connector

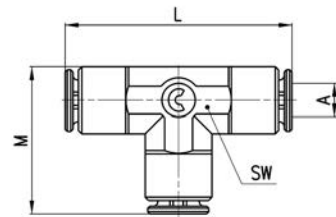

DIMENSIONS

Mod.	A	L	M	SW	Weight (g)
6540 3	3	21,4	13,7	6	4

Fittings Mod. 6540

Tee Connector

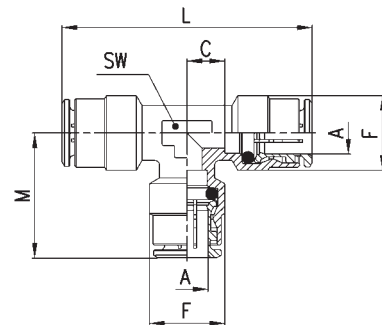

DIMENSIONS

Mod.	A	C	F	L	M	SW	Weight (g)
6540 4	4	3,5	9	35	17,5	8	14
6540 5	5	5,5	10	41	20,5	9	21
6540 6	6	4	12,7	40	20	9	24
6540 8	8	5	14,2	45	22,5	11	32
6540 10	10	5,8	16,5	52	26	13	43
6540 12	12	7,3	19,5	53	26,5	15	60
6540 14	14	8,3	21,5	57	28,5	17	75



Fittings Mod. 6600

Cross Junction

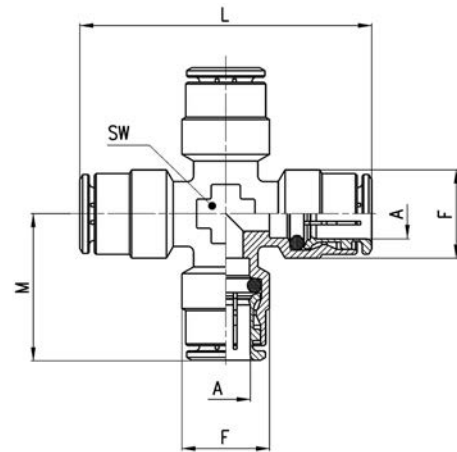

DIMENSIONS

Mod.	A	F	L	M	SW	Weight (g)
6600 4	4	9	38	19	9	26
6600 5	5	10	41	20,5	9	29
6600 6	6	12,7	44	22	10	35
6600 8	8	14,2	49	24,5	12	50
6600 10	10	16,5	55	27,5	14	63
6600 12	12	19,5	56	28	16	84

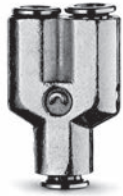

Fittings Mod. 6560 Micro

Y Union

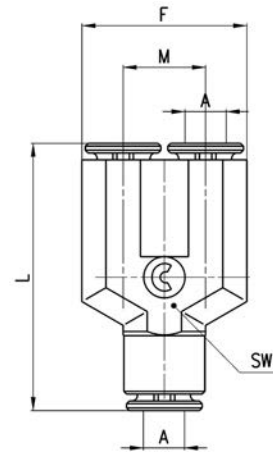

DIMENSIONS

Mod.	A	F	L	M	SW	Weight (g)
6560 3	3	12	20,4	6	6	5



Fittings Mod. 6560

Y Union

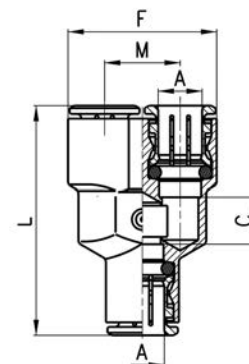

DIMENSIONS

Mod.	A	C	F	L	M	Weight (g)
6560 4	4	5	18	33	9	19
6560 6	6	7	24,5	39	12,5	30
6560 8	8	9	28,5	44	14,5	42
6560 10	10	15,5	32	53,5	16	63

Fittings Mod. 6700 Micro

Cartridge

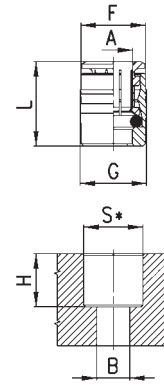

DIMENSIONS								
Mod.	A	B	F	G	H	L	S	Weight (g)
6700 3	3	2	5,9	6,2	6,3	9,2	6	1

Fittings Mod. 6700

Cartridge

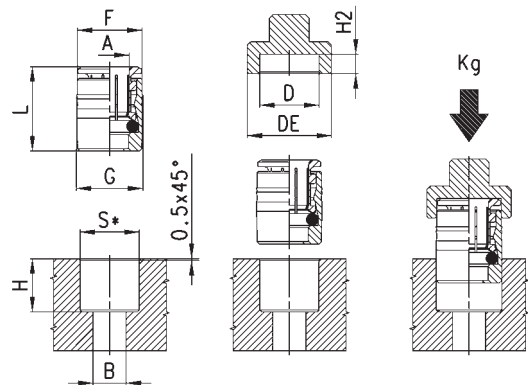

DIMENSIONS													
Mod.	A	B	D	DE	F	G	H	H2	L	S*	P min (Kg)	P max (Kg)	Weight (g)
6700 4	4	3,5	8,8	14	8,6	9	11	3,1	14,5	8,75	314	439	4
6700 5	5	3,5	9,8	15	9,6	10	11,5	3,1	15,5	9,75	251	439	5
6700 6	6	4	12	17	11,8	12,2	12	3,6	16,5	11,95	314	533	8
6700 8	8	6	14	19	13,8	14,2	14	3,1	18	13,95	345	471	11
6700 10	10	8	16	21	15,8	16,2	16,5	3,1	20,5	15,95	439	485	15

S* = metallic (+0.05 -0) or synthetic seat (+0.03 -0,02)

Fittings Mod. 6750

Female Plug

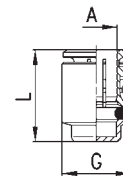

DIMENSIONS				
Mod.	A	G	L	Weight (g)
6750 4	4	8,8	15	4
6750 6	6	11,8	17	7
6750 8	8	13,8	18,5	9
6750 10	10	15,8	21	12
6750 12	12	17,8	20	15

Fittings Mod. 6850

Enlarger Junction

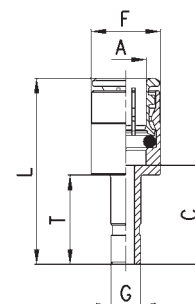

DIMENSIONS							
Mod.	A	G	C	F	L	T	Weight (g)
6850 6-4	6	4	17,5	12,7	33,5	16,5	11
6850 8-6	8	6	19	14	36,5	18	15

Fitting Mod. 6800 Micro

Reducer Junction

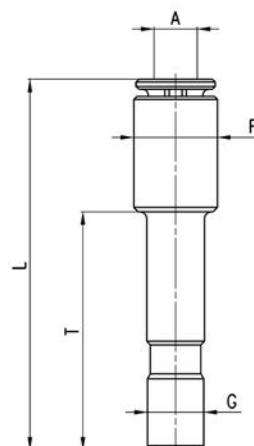
DIMENSIONS

Mod.	A	F	G	L	T	Weight (g)
6800 3-4	3	5,8	4	26	16,5	2

Fittings Mod. 6800

Reducer Junction

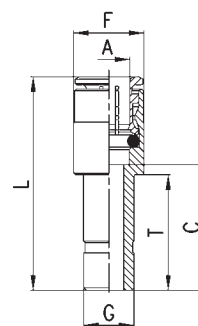
DIMENSIONS

Mod.	A	G	C	F	L	T	Weight (g)
6800 4-5	4	5	19	9	33	18	8
6800 4-6	4	6	15,5	9	29,5	18	9
6800 4-8	4	8	18	9	32	20,5	10
6800 5-6	5	6	19	10	34	18	11
6800 5-8	5	8	18	10	33	20,5	12
6800 6-8	6	8	18	12,7	34	20,5	12
6800 6-10	6	10	20,5	12,7	36,5	23	17
6800 6-12	6	12	17,5	12,7	33,5	24	21
6800 8-10	8	10	20,5	14	38	23	15
6800 8-12	8	12	21,5	14	39	24	22
6800 10-12	10	12	20,3	16,5	40,5	24	27
6800 10-14	10	14	24,3	16,5	44,5	28	33
6800 12-14	12	14	24,3	18,8	45,5	28	27

Fittings Mod. 6950

Junction

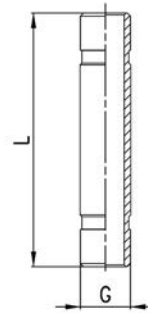

DIMENSIONS			
Mod.	G	L	Weight (g)
6950 4	4	32,5	3
6950 6	6	35,5	4
6950 8	8	40,5	7
6950 10	10	46	10
6950 12	12	48	13
6950 14	14	52	17

Fittings Mod. 6555

Junction Elbow

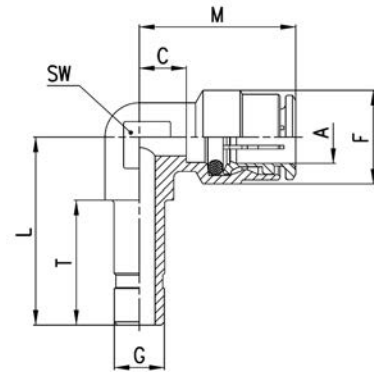

DIMENSIONS									
Mod.	A	G	C	L	F	T	M	SW	Weight (g)
6555 4-4	4	4	3,5	22	9	16,5	17,5	9	8
6555 6-6	6	6	4	24,5	12,7	18	20	9	14
6555 8-8	8	8	5	27,5	14,2	20	22,5	11	21
6555 10-10	10	10	5,8	32	16,5	23	26	13	26

Fittings Mod. 6708

Protection caps
Colour: Black
Self-extinguishing material, class V0

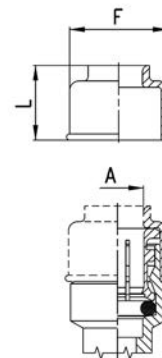

DIMENSIONS				
Mod.	A	F	L	Weight (g)
6708 4	4	10,7	10,7	1
6708 5	5	11,7	11	1
6708 6	6	13,7	11,5	1
6708 8	8	15,7	12,5	1
6708 10	10	18,5	13	1
6708 12	12	20,7	15	2
6708 14	14	23,7	15	2

Accessory Mod. 6900 Micro

Plastic Male Plug

DIMENSIONS

Mod.	G	L	P	T	Weight (g)
6900 3	3	20,5	6	13,5	1

Accessory Mod. 6900

Plastic Male Plug

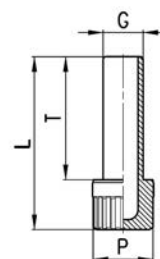
DIMENSIONS

Mod.	G	L	P	T	Weight (g)
6900 4	4	29	8	20	1
6900 5	5	29,5	8	20,5	1
6900 6	6	31,5	8	22,5	1
6900 8	8	34,5	12	24,5	2
6900 10	10	37	12	27	2
6900 12	12	40,5	16	28,5	3
6900 14	14	42,5	16	30,5	3

Accessory Mod. SP

Disconnecting tube set

The set includes keys to disconnect tubes with diameters between 4 and 12 mm.

 Mod.
SP